



Installation and Glazing Guide

Effective October 2015

Contents

Before you start	3
Door Set installation	6
Fixing positions	8
Fixing decorative hardware	9
3D adjustable hinge instructions	10
Challenger 3D Butt Hinge Instructions	12
Avocet Affinity 3D Hinge Instructions	13
Fitting sidepanel into an installed frame	14
Sealing around the perimeter	15
Contemporary Hardware Fittings	16
Door restrictor instructions	18
Glazing instructions	19
Thermal movement definition and tolerances	23

FOR TRACEABILITY DO NOT REMOVE DS JOB NUMBER LABELS FROM FRAME OR LEAF

Before you start

Familiarise yourself with this guide

These instructions must be read and completely understood before any work commences.

Do not remove existing door until you have checked...

- The sizes are correct and you have everything as ordered
 - The paperwork to ensure it is the correct specification
 - Any damage to the door (do not install a damaged door)
-

Health and Safety

Care should be taken when handling the door - help should be sought due to it's weight.

Avoid sharp edge.

Keep electrical leads and cables away from sharp and abrasive surfaces and protect against tension and moisture. An RCD breaker should be used as per manufacturer's instructions to protect from electric shocks.

Keep children and pets away from building operations.

All waste products should be disposed of correctly and safely.

Recommended tools

- Tape measure
 - Hammer
 - Stanley knife
 - Crowbar
 - Chisel
 - Electric drill with hammer action
 - Screwdrivers
(both Phillips and flat head)
 - Silicone sealant gun
 - Saw
 - Rubber mallet
 - Spirit levels
 - 3mm allen key
 - 4mm allen key
 - 6mm socket spanner
 - T15 Torx bit
-

Removing the Existing Door

Remove the existing door leaf.

To help reduce the damage to wall decorations and plaster, score around the perimeter of the frame with a craft knife. Saw through the jambs and remove. The best way to do this is by sawing diagonally in the centre and removing them in two sections.

Do not saw them all the way through as this can cause damage to the internal reveals or structure. If there is a chance this will happen, use a bearing block to protect the plaster and render, then lever the jambs away from the walls and complete the cuts.

Remove the top and bottom rails in the same way.

Preparing the Opening

Once the door has been removed, ensure the opening is free from screws, nails, fillers and mastic.

Repair as required in accordance with BPF recommendations.

The opening should be complete before fitting the door.

Check there's a lintel or other load transferring structure fitted above the doorway.

Door Alignment

The positioning of the door within the brickwork is vital to the correct functioning of the door.

- Frame is square and plumb in both planes
- Door outerframe set back as far as possible to reduce exposure to elements
- Bridge the wall cavity
- Cover the DPC
- Frame is square and not twisted

Lock cylinder fitting instructions

Cylinder is no longer supplied fitted in the lock



See next page for door set fitting instructions...

Door set installation

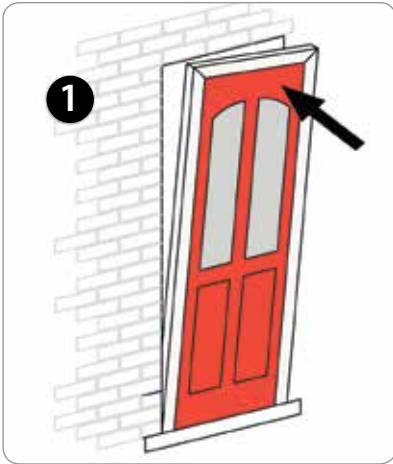

Offer complete door unit into brickwork opening.

Hold frame into position using appropriate size wedge packers. Packers must be located adjacent to fixing positions to prevent distortion of the outer frame when frame fixings are tightened. Failure to adhere to this may result in door function issues.

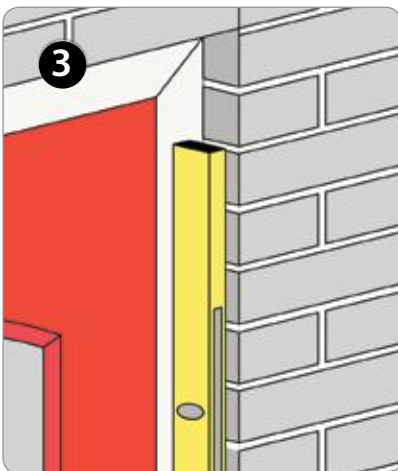
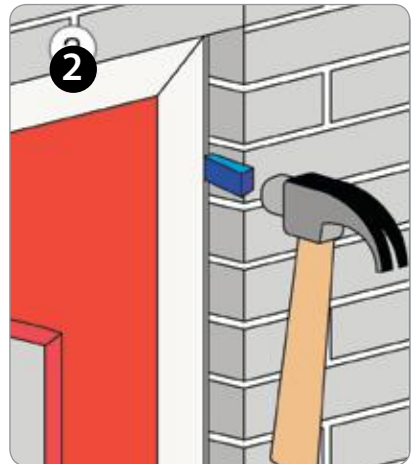

Spirit level (1.5m Long) should be used to ensure jambs are square and plumb in all planes.

Refer to separate hinge instructions on Pages 10 - 13
if you have ordered other than Butt (fixed) Hinges

The leaf may be removed from the frame to ease installation. Final adjustments to frame position may be necessary when using fixed hinges. Once square and plumb, fix as per instructions. (See fixing positions)

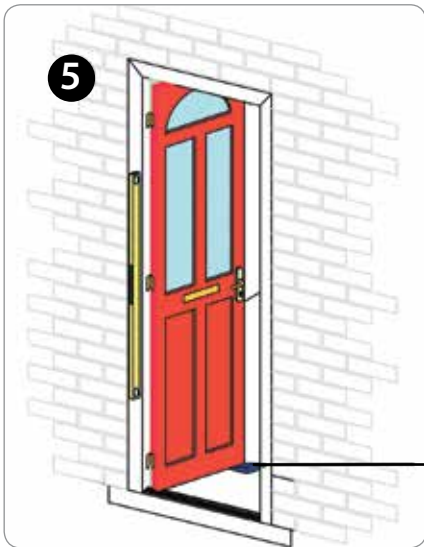

Pack the bottom of the door leaf at the leading edge to assist getting square into outerframe.

Fixing positions

These positions are for guidelines only.

Ensure fixings are into secure substrate.
Recommended fixing positions are as follows:

Corner fixings: 150mm minimum and a maximum of 250mm from external corner.

Intermediate fixings: Centres not exceeding 600mm.

Transoms fixing: Should not be closer than 150mm from transom centre line and no greater than 250mm.

Alternative fixing may be required due to lintel location.

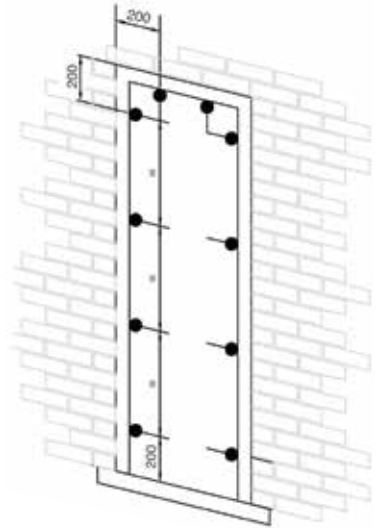

Drilling

Drill holes through the frame as indicated (ensuring the holes are as recommended by the frame fixing manufacturer).

Secure the frame to the brickwork (NOT MORTAR) with suitable frame fixings. Ensure the fixing is secure and correctly positioned in the brickwork.

Fixings

The outerframe should be secured into the brickwork using industry standard plastic sheathed frame fixings.

These should be a minimum of 100mm long and fixed into the masonry by a minimum of 50mm.

Tighten and secure all the fixings to ensure the frame is square.

Care should be taken not to over-tighten the frame fixings to avoid distortion of the frame.

Recommended fixings are plastic sheathed frame fixing bolts minimum length 8 x 100 mm.

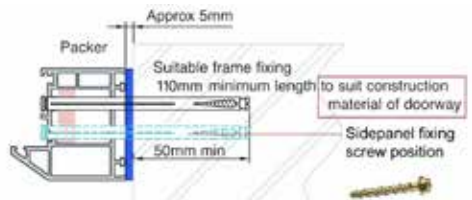

Fixing Side Panel To Main Door Frame

Note the recommended side-panel specific fixing point in the above diagram.

Pre-drill fixing positions required for transom screw (SH01 4.8 x 65mm)

Apply silicone to the entire length between the PVC-U profile and aluminium coupler on both faces.

There should be a minimum of 4 fixings each side of the frame coupling profile.

Ensure fixings are staggered to avoid collision on the opposite side of profile.

Fixing decorative hardware

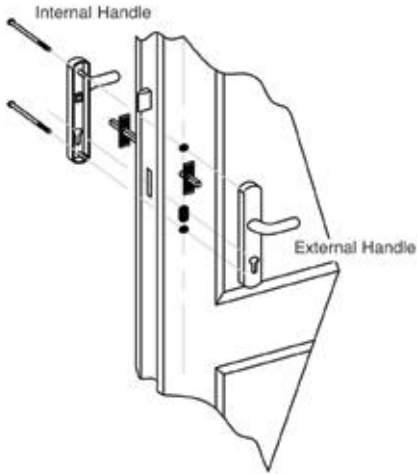

Fixings

To fit door handle set, locate spindle through square hole in lock mechanism. Align projecting pins on internal half of door handle set with pre-drilled holes in door slab.

Ensure handle spring washers are in position and secure using fixing screws supplied.

NB: If your furniture selection is fixed handle for the Slam Lock (Winkhaus AV2), discard spring loaded plate and insert the supplied locking plate. Note the shorter spindle must be used.

NB: When the door has been fixed into position the operation of the door opening and locking mechanism must be checked to ensure uniform contact with weatherseals and correct function of handle/lock.

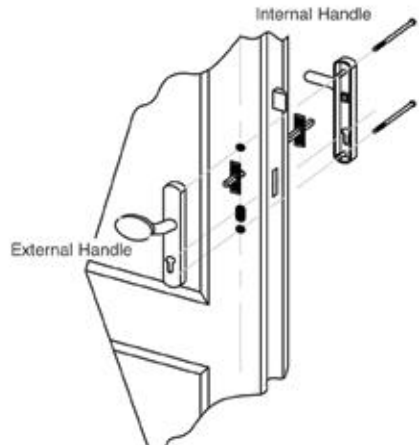

Fixing Security Chain

The security chain should be positioned into the desired location for ease of use (i.e. to suit the persons who will be required to use the device) Mark the fixing positions onto the door/frame using the pre-drilled holes in fittings as a template. Move the security chain and drill pilot holes in the marked positions, use the screws provided to secure.

NB: Care should be taken when the fittings are positioned to ensure the security chain will function correctly.

Fixing Decorative Numerals

Numerals should be located in the desired position on the composite door, when satisfied this is correct, the holes in the numerals should be used as a template to mark the required pilot holes to fix. Drill pilot holes and use the screws provided to secure to the door.

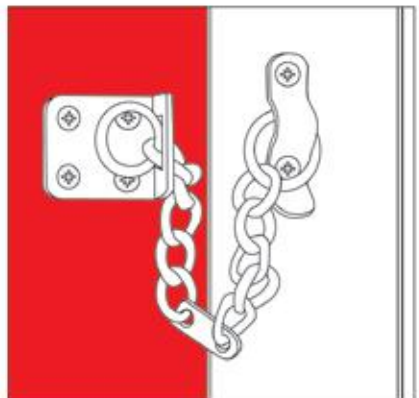

3D adjustable hinge instructions

- A** Frame plate
- B** Slide plate
- C** Socket screw (covered)
- D** Hex pin (covered)

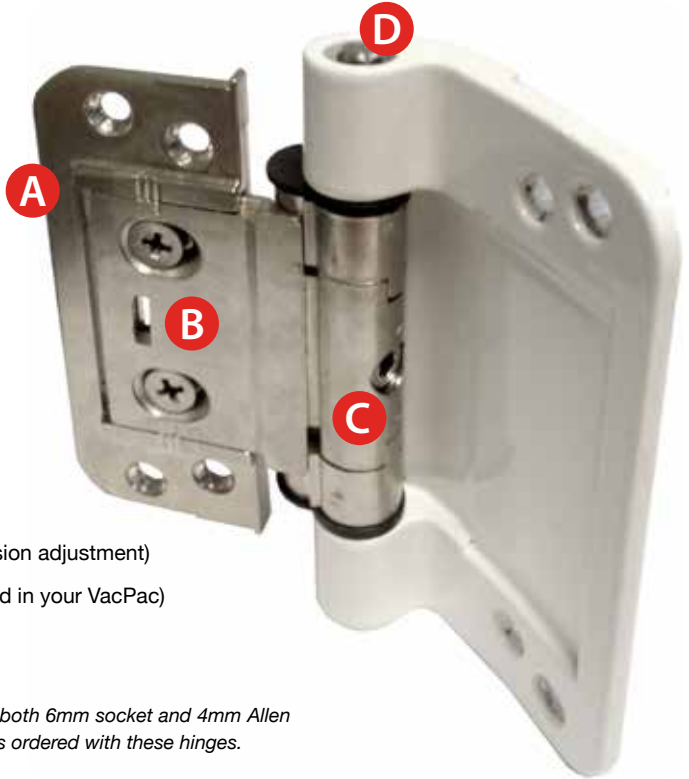

Tools required

- Drill
- Suitable pozi drive bit
- Flat screw driver (for compression adjustment)
- Hinge adjustment tool (supplied in your VacPac)

The adjustment tool that combines both 6mm socket and 4mm Allen key is comes as standard with doors ordered with these hinges.

*Additional tools are available from Door-Stop International.
(part code TRO-ADJUSTMENT-KEY)*

Hanging and removing the door



Remove the 2 screws that clamp side plate (B) to frame plate (A) to all three hinges

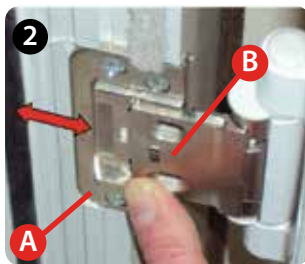

Carefully slide the door away from the frame plates.



Replace the door by reversing steps 1 and 2.

Adjustment instructions (adjust all three at once)

Compression +1.75mm / -1.75mm

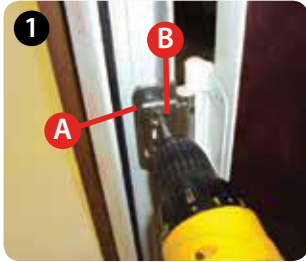

Loosen the 2 screws that clamp side plate (B) to frame plate (A)



Lever the slide plate (B) with a screwdriver in the adjustment slot



Secure the screws in the side plate.

Vertical +4mm / -4mm

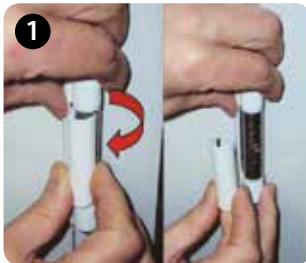

Remove the centre covers by hand.

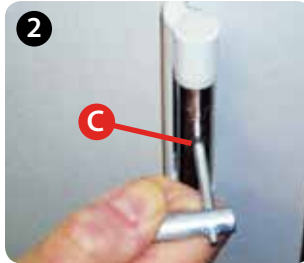

With the 4mm allen key tool loosen the socket screws (C) by about 1/3 of a turn.



Lift and support the door to the required height whilst securing the socket screws. **Take care not to overtighten.** Replace the covers.

Lateral (Side-to side) +3mm / -3mm

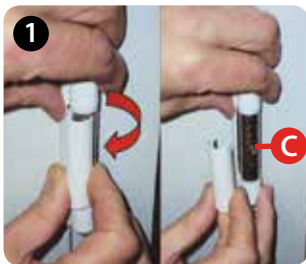

Repeat steps 1 and 2 of the vertical adjustment to one hinge at a time

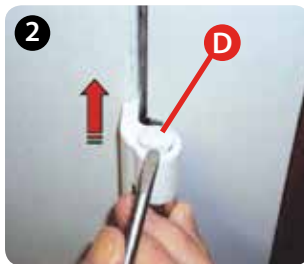

Carefully remove the top cap and with the 6mm socket tool rotate the hex pin (D).



When in position secure the socket screw. **Take care not to overtighten.** Replace the covers.

Challenger 3D Butt Hinge Instructions

Tools required

- 4mm Allen Key
- 5mm Allen Key

WARNING

It is not recommended to fully adjust either one adjuster only or one hinge only. Adjustments should be made gradually, aligning each pair of marks on each hinge until the desired adjustment is achieved.

Compression +0.5mm / -0.5mm (5mm Allen Key)

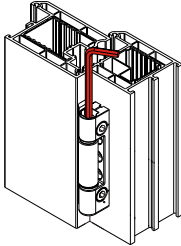

Remove the top cap.

Check pin alignment via mark on top of pin. If the mark is pointing towards the door sash, the adjustment is in the neutral setting.

To increase compression, turn the pin so that the alignment mark is moved towards the door frame.

To reduce compression, turn the pin so that the alignment mark moves away from the frame.

Replace cap.

Vertical Adjustment +3.0mm / - 0.0mm (5mm Allen Key)

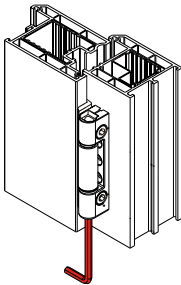

Remove the bottom cap.

To raise door sash, rotate the vertical adjustment screw clockwise. Ensure that all other hinges are adjusted equally.

To lower door sash rotate the vertical adjustment screw anti clockwise. Ensure that all other hinges are adjusted equally.

Replace cap.

Lateral Adjustment +2.0mm / -2.0mm (4mm Allen Key)

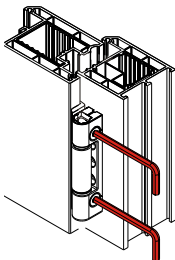

Remove the side cover caps.

Rotate the lateral adjustment drives in the direction required. Ensure that each pair of alignment marks are at the same point.

Replace caps.

IMPORTANT

Remember to tighten the grub screw after adjusting the Challenger Hinge.



Avocet Affinity 3D Hinge Instructions

Tools required

- 5mm Allen Key

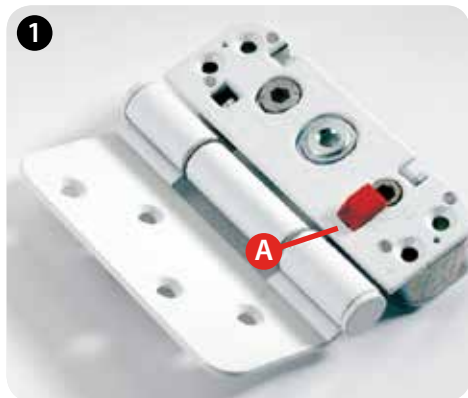

With the door upright pull out and dispose of the red locking wedge (A)



Use a 5mm Allen Key for independent compression, horizontal and lateral adjustments.

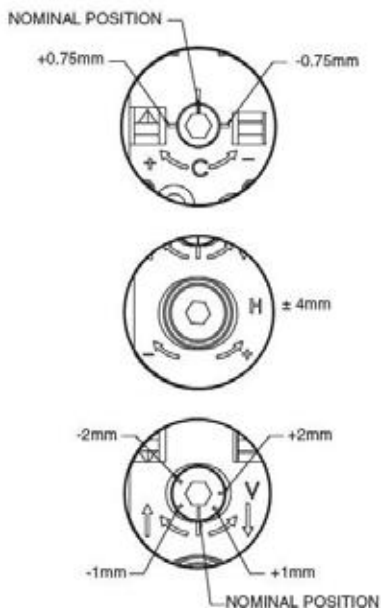

Compression
4.0mm (± 2.0 mm)

Lateral Adjustment
8.0mm (± 4.0 mm)

Vertical Adjustment
1.5mm (± 0.75 mm)

DO NOT FORCE THE ADJUSTMENTS BEYOND THEIR TOLERANCE

Fitting composite sidepanel (into an installed frame)

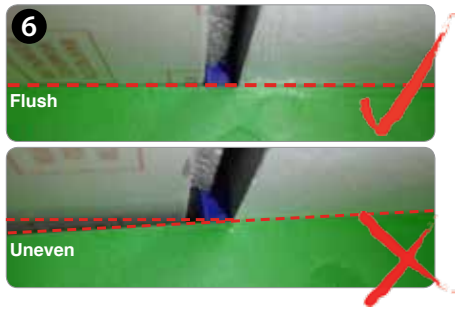
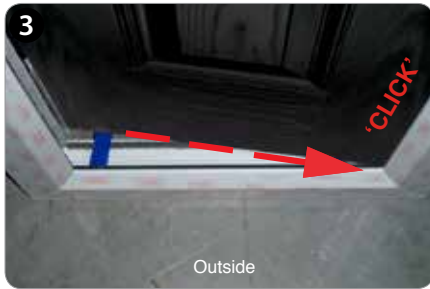
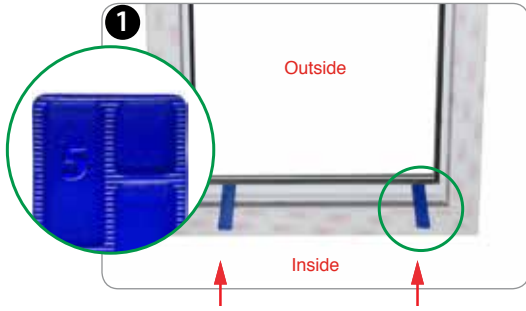

Sealing around the perimeter



Silicone sealant or similar suitable product should be used to seal around the perimeter of the newly installed composite door frame. Ensure that an adequate barrier is formed to prevent water ingress/air leakage.

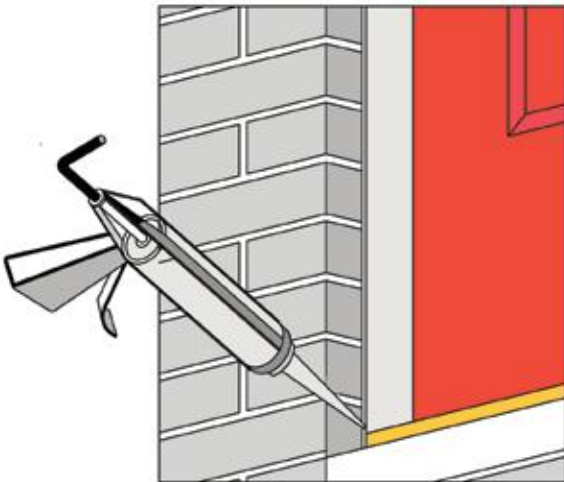

NB: Care must be taken to ensure that the drainage slots are not blocked when sealing around the aluminium wheelchair threshold.

Contemporary Hardware Fittings

Regardless of handle Shape / Design the below instructions are to be used.

Single version - bolt fix

Offset Example from above

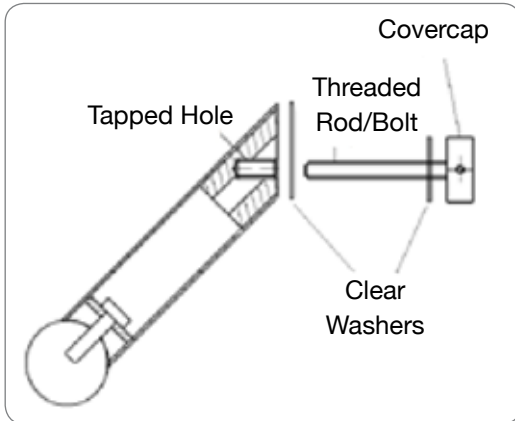

- 1 Assemble the pull handles onto the door as shown. The Covercap and bolt simply push through the door and screw into the pre drilled hole within the pull handle.
- 2 Remember to include clear washers to protect the door surface.

Central Knob from above

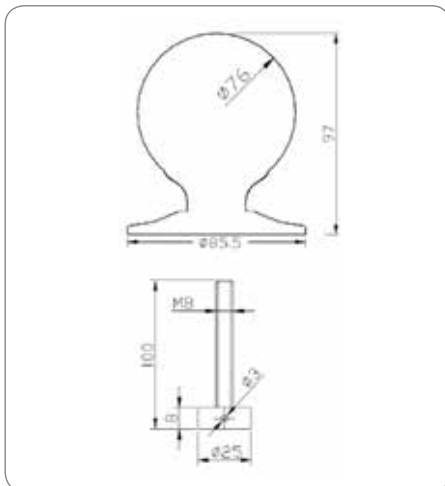

Double version – back to back Fix

Offset Example from above

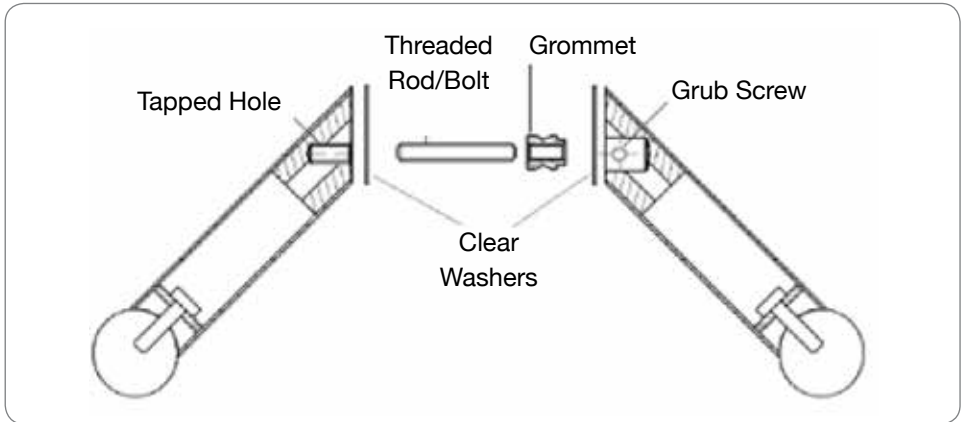

Inline Example as main view

- 1** Assemble the pull handles onto the door as shown. The threaded rod will simply push through the door and screw into the pre drilled hole within the pull handle.
- 2** Add the grommet to the opposite side to assist with rotation and securely hold the items in place.
- 3** Include clear washers to protect the door surface. Once the external pull handle is held in place with the threaded rod and the grommet, add the internal handle.
- 4** Offer the product onto the grommet and fix in place using the grub screws within the neck of the pull handle.

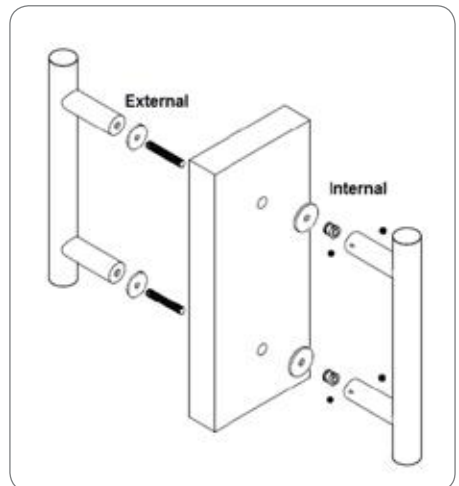

Door restrictor instructions

For outward opening doors

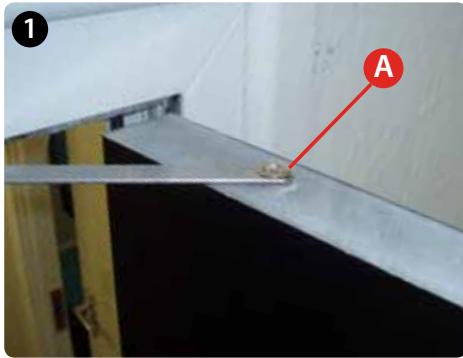

Fix leaf-side of the restrictor using the pre-drilled pilot hole at point A (90mm from hinge side) and one of the supplied screws.



Open the restrictor and locate it in the bead channel of the outer-frame.



Open door to the desired maximum opening angle.



Fix frame-side of the restrictor to the outer frame using the remaining fixing screws at points B & C.

Glazing instructions

If your composite door is unglazed, refer to the following guidelines

Glazing Materials

The following companies are recommended for the glazing materials you will need:

Cassette to glass and door = Clear silicon sealant (Premium+ 450 Builders Silicon – part code 5029347601355) from Everflex,

Tel: 0113 240 3456, e-mail: sales@everbuild.co.uk

web: <http://www.everbuild.co.uk>

Composite Door Glazing Method

Connecting bosses (or lugs) and self tapping screws supplied for each position. Glazing Panel supplier or purchased separately.



Lug for boss positions



Connecting boss

Glazing Method

Trim sealant nozzle to give approximately a 6mm bead.

Clean glazing panel prior to fitting and wipe down door. Ensure both components are fully dry before continuing.

Remove injection sprues from both cassettes prior to fitting. There may be a number on each cassette. They should easily break off by bending gently back and forth.

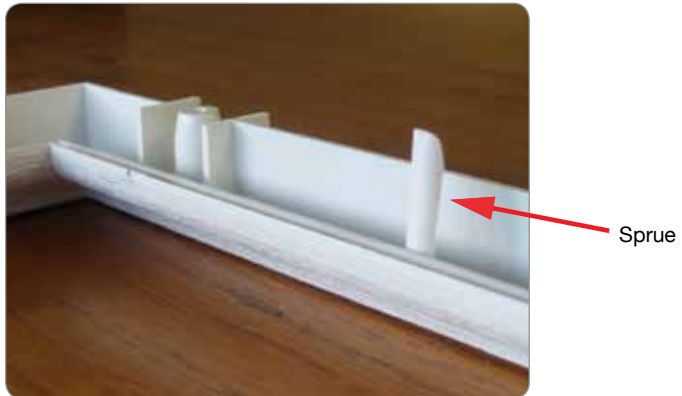

Apply the clear silicon sealant to the door edge and glass edge face of both cassettes. Pay attention to ensure the bead is continuous and complete. If necessary re-apply over thin areas (excess can be removed after fitting).

Sealant **MUST** be all round both cassettes.

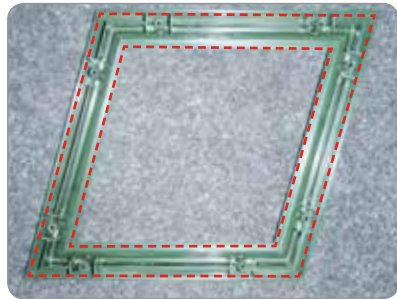
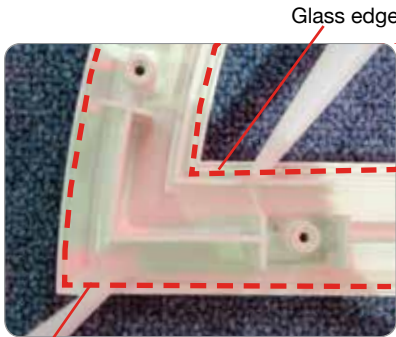

Door edge

Position the external cassette on a flat surface. Ensure cassette is the same colour as the side it is being applied to. Position the door over cassette. Lower the door onto the cassette. Ensure frame is square in door.



Lower the glazing panel into cassette. Ensure it is the correct way round. Push down gently onto sealant.



Fit bosses to every boss position. The low part of the clip touches the glazing panel and the high point touches the door. Screw pinch tight using supplied self tapping screws.

Cassette and glazing panel should be tight.



Boss position



Boss in place



Boss correct way around - low lip on glass



All bosses fitted



Screw retention



NB: Do not overtighten or door may deform.

Place internal cassette over external and tap gently into place. Protect the face with cardboard and use nylon hammer. Each clip should push into place. The bosses are an interference fit.



Wipe any excess silicon from the visual faces with a damp soapy sponge and cloth dry. Avoid rain or dust contact until sealant dries. Complete operation must be completed within 15 minutes of applying silicon.

Thermal movement definition and tolerances

All composite slabs, as do UPVC and timber, experience thermal movement. The slab will recover to its flat plane, to a maximum bow of 3mm side to side and 5mm top to bottom, when the installation recommendations are applied (see below).



Vertical

Deflection of the slab inwards and outwards from top to bottom.

Maximum bow permitted is 5mm measured from the middle of the slab.

Horizontal

Deflection of the slab inwards and outwards from side to side.



Maximum bow permitted is 3mm measured from the middle of the slab.

Slackening off the lock keeps will compensate for the movement of the slab within these tolerances. The hooks of the multipoint lock must be in compression with the inner edge of the pocket keep. If this does not happen the door may move to the inside of the property (towards the cold side) and give the impression the door is bowed. It is important to ensure the centre keep for the latch only allows the door to become flush with the inner face of the outer frame and not any tighter as this could also cause the door to appear bowed.

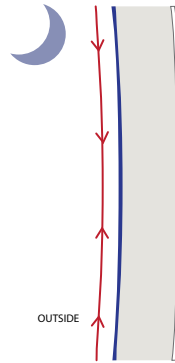
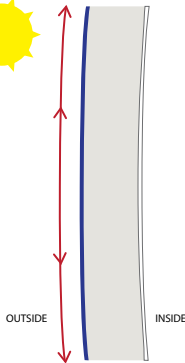

If the hooks on the multipoint lock are not thrown throughout the day and the centre keep setting is too tight, the top and bottom of the door will be in unsupported tension and will eventually stand proud of the inner face of the profile. This will make the hooks on the lock become stiff, as they cannot draw themselves into the hook keep. **Protect your door from natural thermal distortion. Make sure the top and bottom locking points are engaged by pulling the handle up every time you shut the door.**

If these points are not observed the warranties on the functionality and operation of the door could be affected. Condensation issues are typically building ventilation related, not product related.

For further information, contact recognised trade organisations.

Cut out and leave for the homeowner



Keep this number safe for your reference.

Door Number

D	S							
---	---	--	--	--	--	--	--	--

This 'DS Job Number' (or Door Number) can also be found on the inside top of your door's frame, as shown. Do not remove the DS job number labels from frame or leaf for traceability.

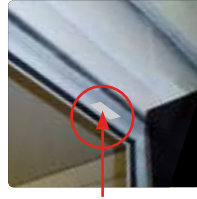

All information in this manual is provided for guidance only.

Door-Stop International Ltd cannot be held responsible for the way in which the information in this manual is interpreted.

We reserve the right to alter specifications and descriptions without prior notice as part of our policy of continual development.

info@urbaneco.uk
www.urbaneco.uk